

TOWER PEAK

INSTALLATION MANUAL



INCLUDED IN THE PACKAGE



GL24H



TOWER 300/400/500/600 + TOWER PEAK

EN
795:2012
A+C

CEN/TS
16415:2013

UNI
11578:2015
A+C

■ TOOLS



■ PRODUCT INFORMATION



TOWER 300/400/500/600 + TOWER PEAK



■ TOWER PEAK DIMENSIONS

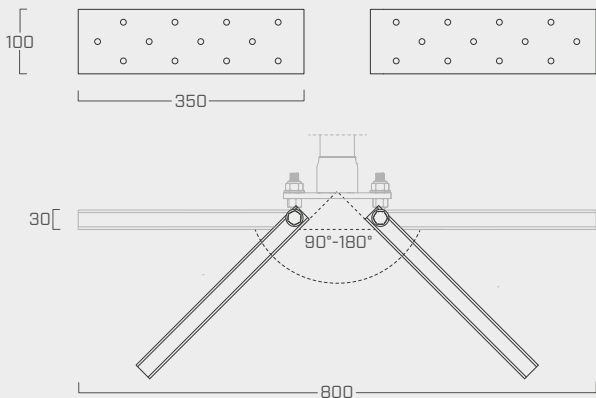

■ LOAD TEST MODEL TOWER 300/400/500/600 + TOWERPEAK

- IT ⚠ Verificare idoneità statica del sottofondo di montaggio!
- DE ⚠ Die statische Eignung des Montageuntergrundes sicherstellen!
- EN ⚠ Check the static suitability of the installation substrate!
- ES ⚠ ¡Compruebe la idoneidad estática del sustrato de montaje!
- FR ⚠ Vérifier l'adéquation statique du substrat d'assemblage!

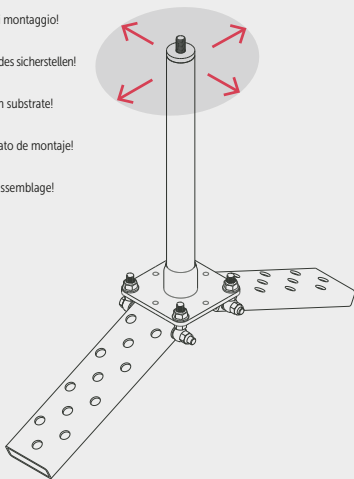

TOWER PEAK TOWER INSTALLATION

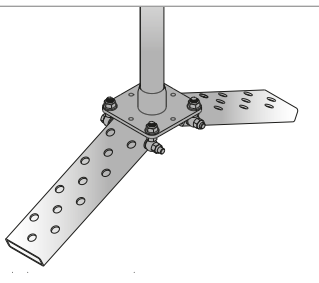
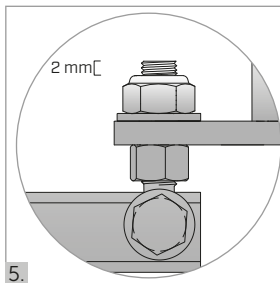
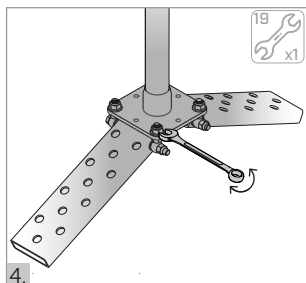
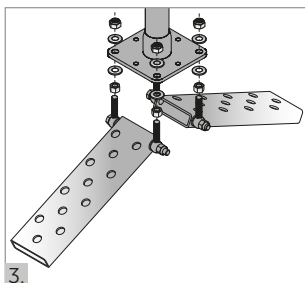
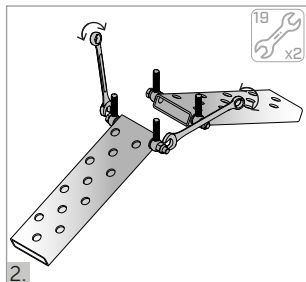
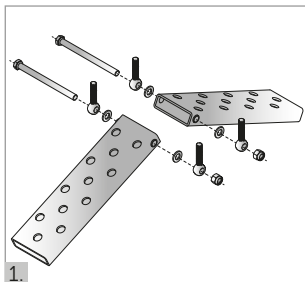

TOWER PEAK WOOD SUBSTRUCTURE



GL24H



19

x2



HBS

x24

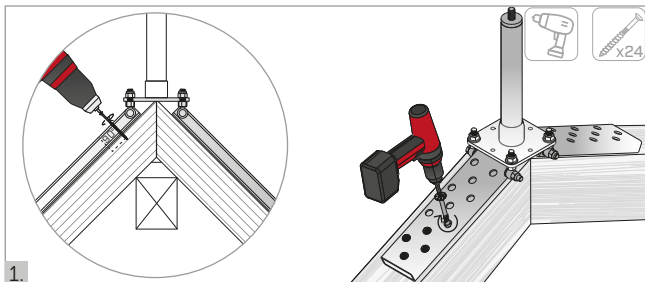

1.

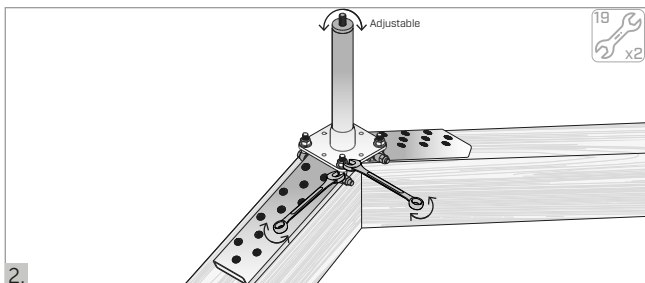

2.

HBS 8 x L mm

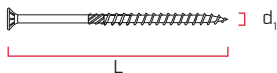
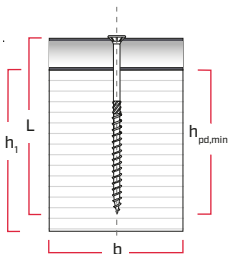

| | | | | | |
|-------|---|--------|--------------|---|--------------|
| d_1 | = | 8 mm | h_1 | ≥ | 100 mm |
| b | ≥ | 100 mm | $h_{pd,min}$ | ≥ | 80 mm |
| L | ≥ | 120 mm | h_1 | ≥ | $h_{pd,min}$ |

TOWER PEAK SUBSTRUCTURE WITH INSULATING PANEL



GL24H

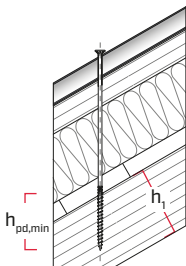
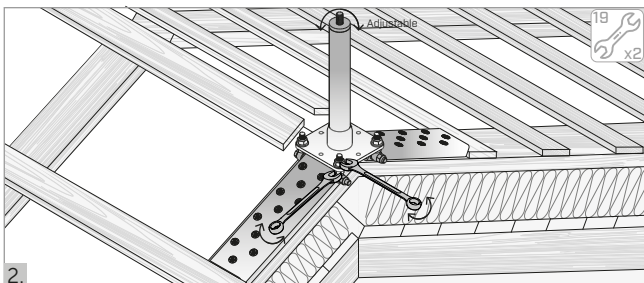
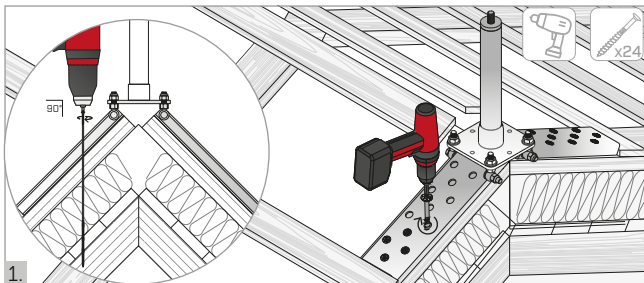

Beam profile min 100 x 100 mm

HBS B x L mm

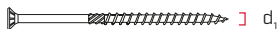

$$\begin{array}{l} d_1 = 8 \text{ mm} \\ h_1 \geq 100 \text{ mm} \end{array} \quad \left| \quad \begin{array}{l} h_{pd,min} \geq 80 \text{ mm} \end{array} \right.$$



Rotho Blaas Srl

03-23

Via dell'Adige N.2/1 | 39040, Cortaccia (BZ) | Italia
Tel: +39 0471 81 84 00 | Fax: +39 0471 81 84 84
info@rothoblaas.com | www.rothoblaas.com

